

NEVADA-3X



8-20 cm

3D letters, lightboxes



- luminous efficacy 100 lm/W
- for indoor and outdoor use
- 20 pcs in chain

DIMENSIONS

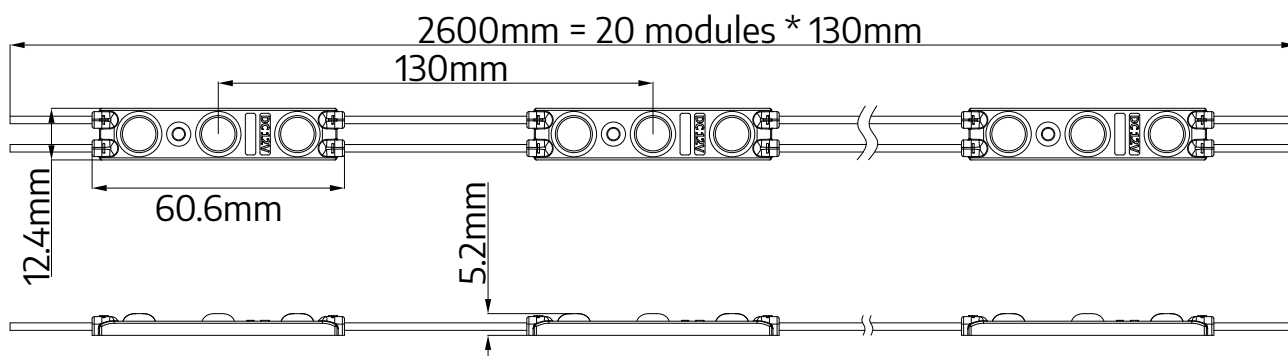

NEVADA-3X



TECHNICAL SPECIFICATION

Parameter	Value
Rated voltage	12 V DC
Power consumption per module	1,2 W
Chain power consumption	24 W
Current consumption per module	100 mA
LED diodes	EPISTAR - 2835
Quantity of LEDs	3
Light color	X = W - white (6500K) X = CW - cold white (9500K)
Flux	120 lm (W) 115 lm (CW)
Flux density	100 lm/W (W) 96 lm/W (CW)
Color rendering index CRI	≥80 (on request ≥90, ≥95)
Beam angle	160°
Current stabilization	No
Dimming	Yes
Module dimensions (L × W × H)	61 × 12 × 5 mm
Cable length	70 mm
Number of modules in 1 m	7,7
Box weight	17 kg
Montage	Adhesive tape / mounting screw
Lifetime	L70B50 > 50000h
Working temperature	-25°C ... +55°C
IP protection	IP67
Warranty	4 years

NEVADA-3X



CONNECTION DIAGRAM

One-side power input



Maximum number of modules 20 pcs

Two-side power input



Maximum number of modules 40 pcs

It is acceptable to connect multiple chains in parallel, as long as the power supply provides sufficient power.

ENERGY LABEL / BEAM ANGLE

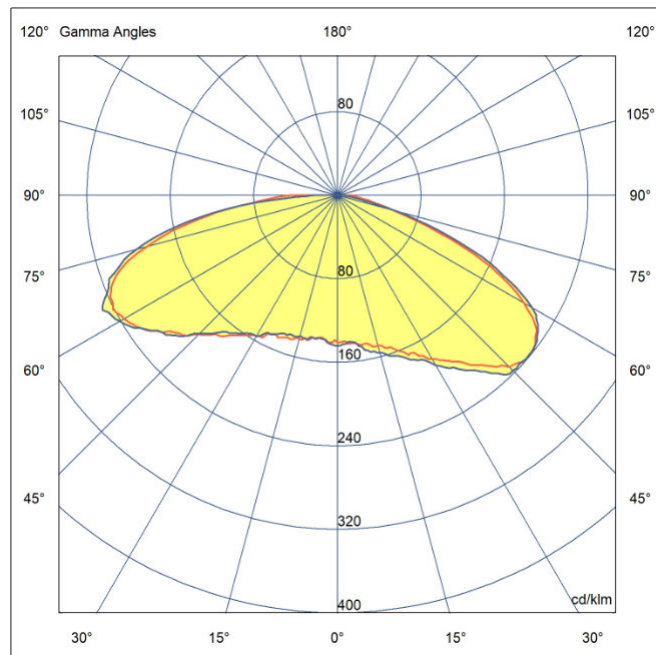
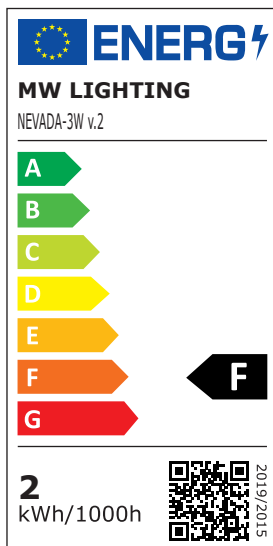

LIGHT COLOR / CCT

Abbreviation	Light color	CCT
WW	warm white	~3000K
NW	neutral white	~4000K
W	white	~6500K
CW	cold white	~9500K

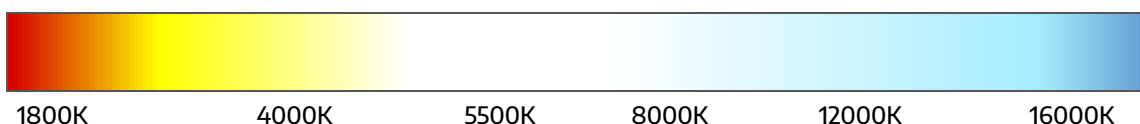

NEVADA-3X



APPLICATION

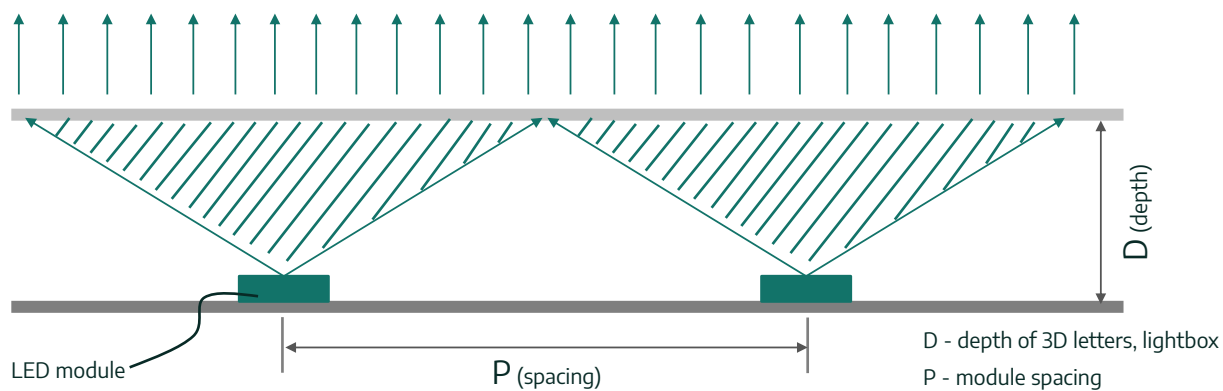

$$\text{optical performance proportion} = \frac{D}{P} = 1:1.5$$

PACKING

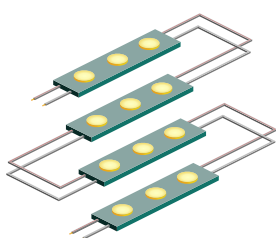

Chain
20 pcs



Bag
100 pcs

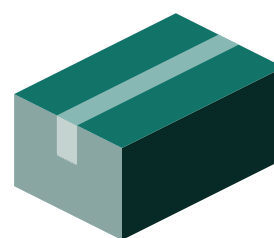

Box
2600 pcs